



SERIES VRG230



Mtrl.n: 9814 02 72 • Ritn.n: 7048 utg D • Rev. 2022-01-05



Series VRG231
Series VRG232
Series VRG233
Series VRG238



PED 2014/68/EU, article 4.3

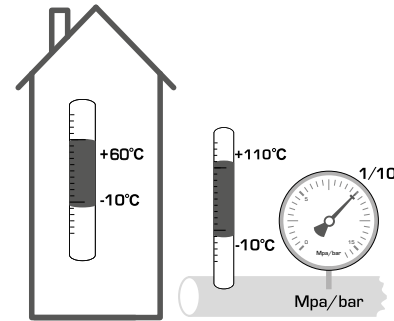

1

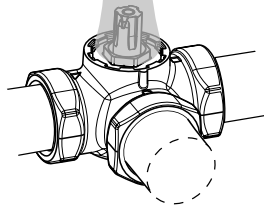
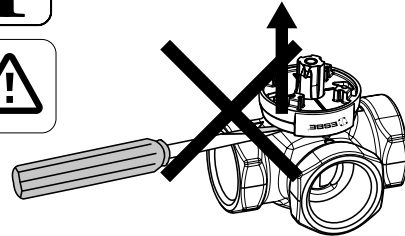
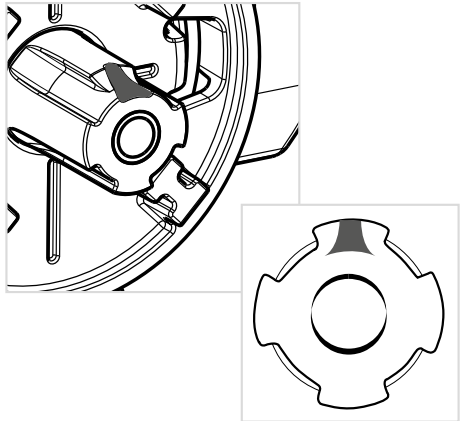
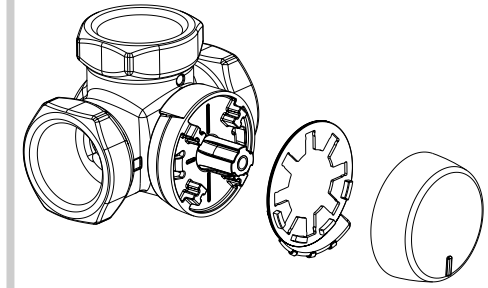

Piping Schematics are General Representations

2

a

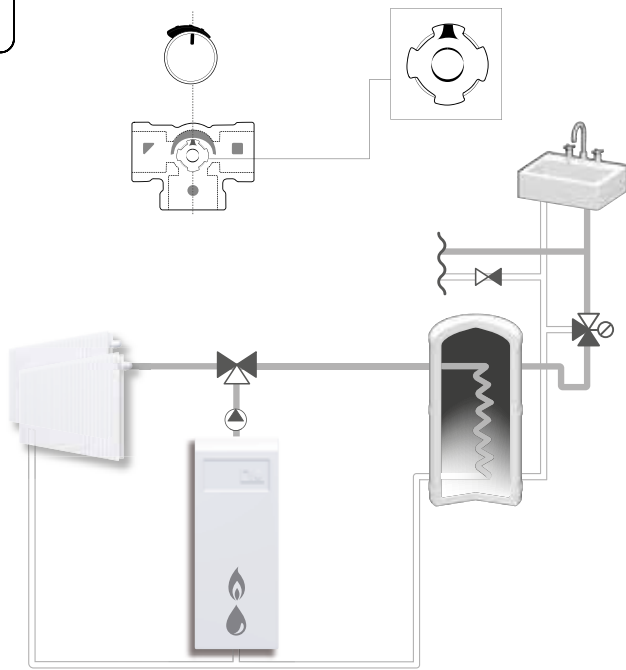

b

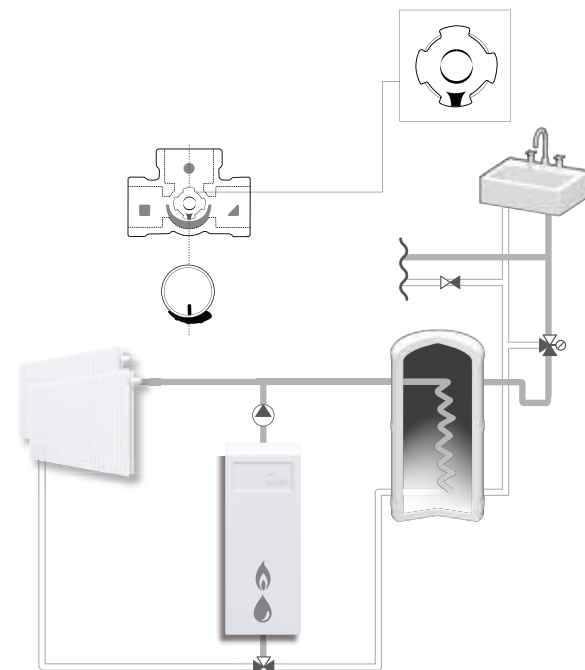

i



<http://www.esbe.eu/global/en/products/rotary-valves>