



SERIES VRG140



Mtrl.nr: 9814 02 70 • Ritn.nr: 7046 vers. D • Rev. 2022-01-05



Series VRG141
Series VRG142
Series VRG143



PED 2014/68/EU, article 4.3

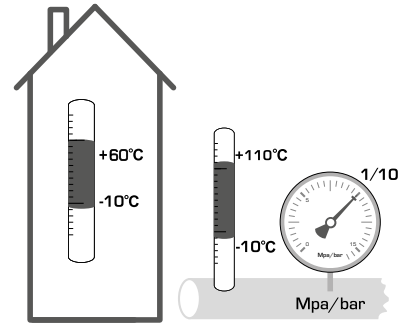

1

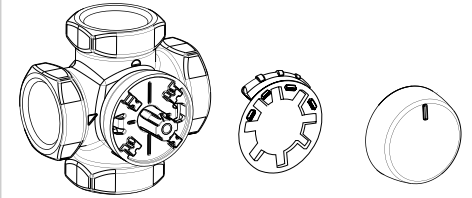

i

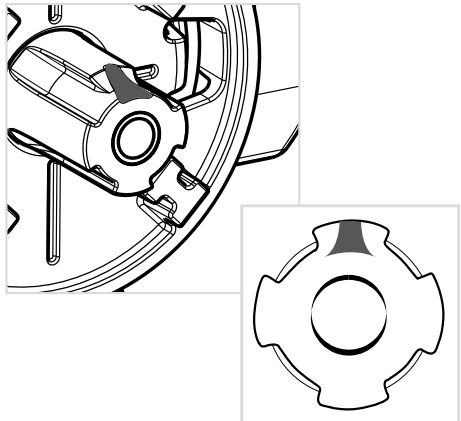

i

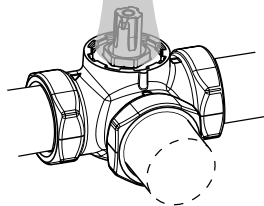
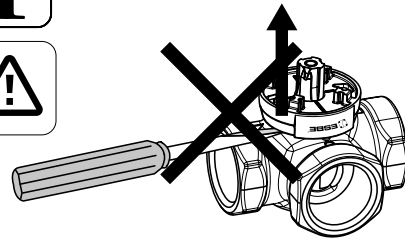

2

a

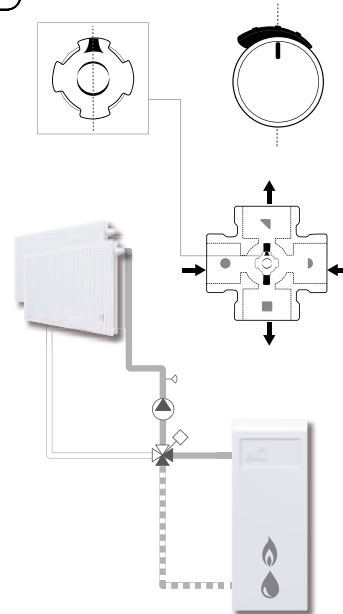

b

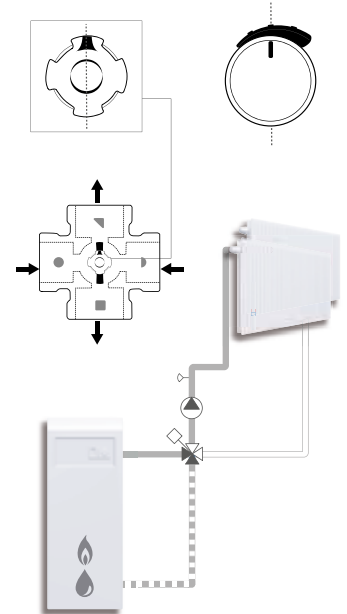

Piping Schematics are General Representations



[http://www.esbe.eu/global/en/
products/rotary-valves](http://www.esbe.eu/global/en/products/rotary-valves)